

RING TYPE JOINTS

The metallic Ring Type Joint is used in the petroleum industry, where high pressure applications necessitate the need for a high integrity seal.



FLEXITALLIC

THE FLEXITALLIC GROUP IS THE INTERNATIONAL MARKET LEADER IN THE MANUFACTURE AND SUPPLY OF HIGH QUALITY, HIGH VALUE INDUSTRIAL STATIC SEALING PRODUCTS.

ABOUT US

As the developer of the spiral wound gasket in 1912, we have built on this legacy of innovation with revolutionary products including Thermiculite®, Sigma®, Change™ Gasket and more recently Corriculite®, our tightest sealing material, which is set to transform the global sealing industry.

We have a global network of Allied Distributors across 30 countries. This ensures local demand is met quickly, providing a combination of the highest product quality and outstanding customer service.

Our extensive and varied product offering includes spiral wound gaskets, RTJ gaskets, Flexpro™ Kammprofiles, sheet materials, dynamic and static packings, pipe support and custom rubber products. Drawing upon the group's rich history and present day values of leadership, quality, service and technology, we are at the forefront of developing sealing solutions for industries around the world.

In addition to a wide range of products, we also deliver world-class technical support and Joint Integrity training.

OUR MISSION

MAKING THE WORLD SAFER AND CLEANER THROUGH ENGINEERED SEALING SOLUTIONS.





BASED ON SALES AND GEOGRAPHIC REACH, THE FLEXITALLIC GROUP HAS BECOME *THE* GLOBAL SUPPLIER OF INDUSTRIAL GASKETS.

INNOVATIVE PRODUCT RANGE

We have a rich history of innovation, which has seen us lead the industry with many new products.

Over the years, our products have gained a reputation for quality, reliability and technology that is second to none.

CUSTOMISED ENGINEERING SOLUTIONS

Our Application Engineering, Production Engineering and R&D teams work closely together to design, develop and manufacture bespoke sealing solutions. We have been responsible for a number of truly revolutionary products, including Thermiculite[®], Sigma[®] and Corriculite[®], which ensures we are able to continually meet the ever more stringent requirements of our customers.

FLEXITALLIC[®] SAFE

Over the last century, our aggressive R&D efforts have helped customers become Flexitallic[®] Safe. From the first Spiral Wound Gasket in 1912 to the ever evolving applications for Thermiculite[®], our goal is to develop materials that push the parameters of heat, pressure and chemical resistance.

OUR COMMITMENT TO QUALITY

We place great emphasis on maintaining international quality standards, and are approved to ISO 9001: 2015, ISO 14001:2015, ISO 45001: 2018, API 6A and API 17D, to ensure we meet the highest possible standards for all our products and services. We also invest heavily in test and quality assurance equipment to maintain our reputation for the highest quality products.

Our materials are subjected to a wide range of tests as specified by statutory regulations and customer requirements. These approvals enable our customers to make informed choices as to the suitability of a product for each and every application.

INSIDE INDUSTRY

We pride ourselves on not simply supplying products, but by supporting customers with a detailed knowledge of their industry and applications, so that products and services are tailored to their specific needs. This unique approach means that we focus on providing more than just a product, but also a complete solution that adds genuine value to our clients.

GLOBAL DISTRIBUTION... LOCAL SUPPORT

Our products are distributed through a global network of Allied Distributors. These carefully selected distribution partners are strategically located within their territory to deliver the best possible service and products to our customers. This approach means our products and know-how are available to the global industries we service.

Allied Distributor



Licensee Manufacturer



RING TYPE JOINTS

THE METALLIC RING TYPE JOINT IS USED IN THE PETROLEUM INDUSTRY, WHERE HIGH PRESSURE APPLICATIONS NECESSITATE THE NEED FOR A HIGH INTEGRITY SEAL.

All Flexitallic Ring Type Joints are manufactured in accordance with the industry standards API 6A, API 17D, ASME B16.20 or to specific customer requirements. Flexitallic produce these Ring Type Joints from fully traceable materials and are supplied to NACE specifications upon request. Ring Type Joints manufactured to ASME B16.20 are permanently marked according to standard. Each Ring Type Joint manufactured to an API standard is identified by low stress stamping with style, ring number, API license number, material reference, Product Specification Level 4 (PSL-4), a unique Flexitallic material identification number, and month and year of manufacture. Such full and comprehensive traceability, from material source with mill certification to final supply, is an essential ingredient of the company's strict quality assurance procedures and exceed those demanded by the highest API 6A and 17D approvals.

MATERIALS

The gasket material should be selected to suit the service conditions. It is always recommended that the gasket material be softer than the mating flanges. The more popular Ring Type Joint materials, with the stated maximum hardness and identification as specified in API 6A and ASME B16.20, are shown in the table below.

For more highly specialised applications, Ring Type Joints can be machined from Duplex steels and other exotic materials such as Inconel®, Incoloy®, and Hastelloy®. The Technical Department is available to advise on other materials.

PROTECTIVE COATING

In accordance with API Specifications, soft iron and low carbon steel Ring Type Joints are protected with electroplated zinc to a maximum thickness of 8µm. Alternative material coatings can be supplied on request.

MATERIAL	UNS NUMBER	MAXIMUM HARDNESS		IDENTIFICATION note (b)	SPECIFYING BODY note (c)
		BRINELL (BHN)	ROCKWELL (RB)		
Soft Iron	-	90	56	D	A, B
Low Carbon Steel - note (a)	-	120	68	S	A, B
4-6% Chrome 1/2% Moly (F5)	K42544	130	75	F5	B
St. St. AISI 304	S30400	160	83	S304	A, B
St. St. AISI 316	S31600	160	83	S316	A, B
St. St. AISI 347	S34700	160	83	S347	A, B
St. St. AISI 410	S41000	170	86	S410	B
Alloy 600	N06600	200	92	UNS Number	C
Alloy 625	N06625	200	92	UNS Number	C
Alloy 800	N08800	200	92	UNS Number	C
Alloy 825	N08825	200	92	UNS Number	C
Alloy C276	N10276	200	92	UNS Number	C
SMO 254	S31254	180	89	UNS Number	C
Duplex	S31803	250	-	UNS Number	C
Super Duplex	S32760	200	92	UNS Number	C
Monel® 400 (M400)	N04400	200	92	UNS Number	C
Titanium Gr.2	R50400	215	94	UNS Number	C



Low stress stamping for identification and traceability

NOTES

- (a) The maximum hardness values applied to Soft Iron may be required for Low Carbon Steel
- (b) Material identification of RTJ's manufactured in accordance with API-6A will include '- 4' immediately after the material identification. Eg. S316-4.
- (c) The maximum hardness values listed are specified by the following bodies: A = API, B = ASME, C = Flexitallic.

STYLE R

The Ring Type Joint was initially developed for high pressure/temperature applications found in the petroleum industry and is primarily used in the oil field on drilling and completion equipment. However, today this product range can also be found on valves and pipework assemblies, along with some high integrity pressure vessel joints.

STANDARD STYLE R RING TYPE JOINTS

These are manufactured in accordance with ASME B16.20 or API 6A. Available in both oval and octagonal configurations, both types are interchangeable on the modern octagonal type grooved flanges.

As with all solid metal Ring Type Joints including Style R, it is recommended to replace the ring when flanged connection is broken.

STYLE R TOLERANCES

Dimension	Tolerances (mm)	
	API 6A & 17D	ASME B16.20
A Width of ring	40.20	40.20
B, H Height of ring	±0.5	+1.3/-0.5
C Width of flat	±0.20	±0.20
P Average pitch diameter	±0.18	±0.18
23° Angle of sealing face	±0° 30'	±0° 30'

Surface finish of the Style R Ring Type Joint sealing faces (radiused ends of an Oval and the 23° angled faces of an Octagonal shape) shall not be greater than 1.6 µm Ra / 63 µin RMS. Flexitallic Style R Ring Type Joints can be manufactured in accordance with all relevant standards to suit the following flange designs:

API 6A

ASME B16.5

ASME B16.47 SERIES A

BS1560

DIMENSIONAL DATA - STYLE -R

OVAL

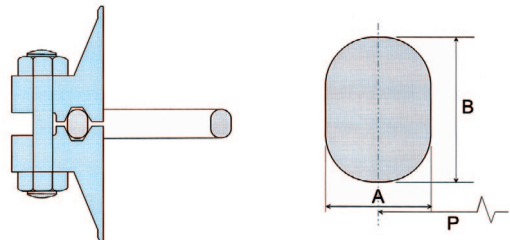

OCTAGONAL

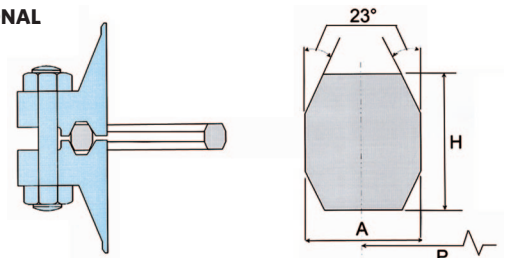

DIMENSIONAL DATA

RING TYPE JOINTS

ASME B16.20 and API 6A

Style R

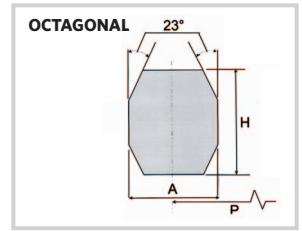
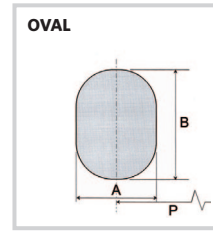

RING NUMBER	PRESSURE CLASS RATINGS								PITCH DIA. OF RING	WIDTH OF RING	HEIGHT OF RING		APPROX DIST. BETWEEN MADE UP FLANGES (mm)
	ASME B16.5 & ASME B16.47 SERIES A					API 6A (psi)					OVAL	OCTAG	
	150	300/600	900	1500	2500	2000	3000	5000			B	H	
	NOMINAL PIPE SIZES										P	A	
R 11	-	1/2	-	-	-	-	-	-	34.14	6.35	11.2	9.7	-
R 12	-	-	1/2	1/2	-	-	-	-	39.70	7.95	14.2	12.7	-
R 13	-	3/4	-	-	1/2	-	-	-	42.88	7.95	14.2	12.7	-
R 14	-	-	3/4	3/4	-	-	-	-	44.45	7.95	14.2	12.7	-
R 15	1	-	-	-	-	-	-	-	47.63	7.95	14.2	12.7	-
R 16	-	1	1	1	3/4	-	-	-	50.80	7.95	14.2	12.7	-
R 17	1 1/4	-	-	-	-	1	1	1	57.15	7.95	14.2	12.7	-
R 18	-	1 1/4	1 1/4	1 1/4	1	1 1/4	1 1/4	1 1/4	60.33	7.95	14.2	12.7	-
R 19	1 1/2	-	-	-	-	-	-	-	65.10	7.95	14.2	12.7	-
R 20*	-	1 1/2	1 1/2	1 1/2	-	1 1/2	1 1/2	1 1/2	68.28	7.95	14.3	12.7	4.1
R 21	-	-	-	-	1 1/4	-	-	-	72.24	11.13	17.5	16.0	-
R 22	2	-	-	-	-	-	-	-	82.55	7.95	14.2	12.7	-
R 23*	-	2	-	-	1 1/2	-	-	-	82.55	11.13	17.5	15.9	4.8
R 24*	-	-	2	2	-	-	2	2	95.25	11.13	17.5	15.9	4.8
R 25	2 1/2	-	-	-	-	-	-	-	101.60	7.95	14.2	12.7	-
R 26*	-	2 1/2	-	-	2	2 1/2	-	-	101.60	11.13	17.5	15.9	4.8
R 27*	-	-	2 1/2	-	-	-	2 1/2	2 1/2	107.95	11.13	17.5	15.9	4.8
R 28	-	-	-	-	2 1/2	-	-	-	111.13	12.70	19.1	17.5	-
R 29	3	-	-	-	-	-	-	-	114.30	7.95	14.2	12.7	-
R 30 (a)	-	3	-	-	-	-	-	-	117.48	11.13	17.5	16.0	-
R 31*	-	3	3	-	-	3	3	-	123.83	11.13	17.5	15.9	4.8
R 32	-	-	-	-	3	-	-	-	127.00	12.70	19.1	17.5	-
R 33	3 1/2	-	-	-	-	-	-	-	131.78	7.95	14.2	12.7	-
R 34	-	3 1/2	-	-	-	-	-	-	131.78	11.13	17.5	16.0	-
R 35*	-	-	-	3	-	-	-	3	136.53	11.13	17.5	15.9	4.8
R 36	4	-	-	-	-	-	-	-	149.23	7.95	14.2	12.7	-
R 37*	-	4	4	-	-	4	4	3 1/2	149.23	11.13	17.5	15.9	4.8
R 38	-	-	-	-	4	-	-	-	157.18	15.88	22.4	20.6	-
R 39*	-	-	-	4	-	-	-	4	161.93	11.13	17.5	16.0	4.8
R 40	5	-	-	-	-	-	-	-	171.45	7.95	14.2	12.7	-
R 41*	-	5	5	-	-	5	5	-	180.98	11.13	17.5	15.9	-
R 42	-	-	-	-	5	-	-	-	190.50	19.05	25.4	23.9	-
R 43	6	-	-	-	-	-	-	-	193.68	7.95	14.2	12.7	-
R 44*	-	-	-	5	-	-	-	5	193.68	11.13	17.5	15.9	4.8
R 45*	-	6	6	-	-	6	6	-	211.15	11.13	17.5	15.9	4.8
R 46*	-	-	-	6	-	-	-	6	211.15	12.70	19.1	17.5	4.8
R 47*	-	-	-	-	6	-	-	6	228.60	19.05	25.4	23.9	4.1
R 48	8	-	-	-	-	-	-	-	247.65	7.95	14.2	12.7	-
R 49*	-	8	8	-	-	8	8	-	269.88	11.13	17.5	15.9	4.8
R 50*	-	-	-	8	-	-	-	8	269.88	15.88	22.4	20.6	4.1
R 51	-	-	-	-	8	-	-	-	279.40	22.23	28.7	26.9	-
R 52	10	-	-	-	-	-	-	-	304.80	7.95	14.2	12.7	-
R 53*	-	10	10	-	-	10	10	-	323.85	11.13	17.5	15.9	4.8
R 54*	-	-	-	10	-	-	-	10	323.85	15.88	22.4	20.6	4.1
R 55	-	-	-	-	10	-	-	-	342.90	28.58	36.6	35.1	-
R 56	12	-	-	-	-	-	-	-	381.00	7.95	14.2	12.7	-
R 57*	-	12	12	-	-	12	12	-	381.00	11.13	17.5	15.9	4.8

NOTES: *Denotes ring number specified in API 6A.

DIMENSIONAL DATA

RING TYPE JOINTS

ASME B16.20 and API 6A

Style R

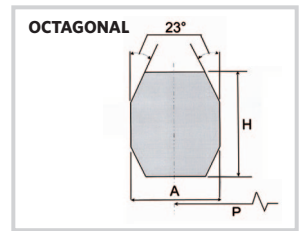
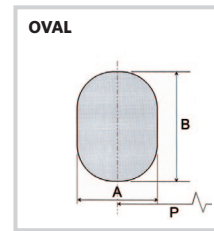

RING NUMBER	PRESSURE CLASS RATINGS								PITCH DIA. OF RING P ±0.18	WIDTH OF RING A ±0.20	HEIGHT OF RING		APPROX DIST. BETWEEN MADE UP FLANGES (mm)
	ASME B16.5 & ASME B16.47 SERIES A					API 6A (psi)					OVAL	OCTAG	
	150	300/600	900	1500	2500	2000	3000	5000			B ±0.50	H ±0.50	
	NOMINAL PIPE SIZES												
R 58	-	-	-	12	-	-	-	-	381.00	22.23	28.7	26.9	-
R 59	14	-	-	-	-	-	-	-	381.88	7.95	14.2	12.7	-
R 60	-	-	-	-	12	-	-	-	406.40	31.75	39.6	38.1	-
R 61	-	14	-	-	-	14	14	-	419.10	11.13	17.5	16.0	-
R 62	-	-	14	-	-	-	-	-	419.20	15.88	22.4	20.6	-
R 63*	-	-	-	14	-	-	-	-	419.00	25.40	33.3	31.8	5.6
R 64	16	-	-	-	-	-	-	-	454.03	7.95	14.2	12.7	-
R 65*	-	16	-	-	-	16	-	-	469.90	11.13	17.5	15.9	4.8
R 66*	-	-	16	-	-	-	16	-	469.90	15.88	22.4	20.6	4.1
R 67	-	-	-	16	-	-	-	-	517.53	28.58	36.6	35.1	-
R 68	18	-	-	-	-	-	-	-	533.40	7.95	14.2	12.7	-
R 69*	-	18	-	-	-	18	-	-	533.40	11.13	17.5	15.9	4.8
R 70*	-	-	18	-	-	-	18	-	533.40	19.05	25.4	23.9	4.8
R 71	-	-	-	18	-	-	-	-	533.40	28.58	36.6	35.1	-
R 72	20	-	-	-	-	-	-	-	558.80	7.95	14.2	12.7	-
R 73*	-	20	-	-	-	20	-	-	584.20	12.70	19.1	17.5	3.3
R 74*	-	-	20	-	-	-	20	-	584.20	19.05	25.4	23.9	4.8
R 75	-	-	-	20	-	-	-	-	584.20	31.75	39.6	38.1	-
R 76	24	-	-	-	-	-	-	-	673.10	7.95	14.2	12.7	-
R 77	-	24	-	-	-	-	-	-	692.15	15.88	22.4	20.6	-
R 78	-	-	24	-	-	-	-	-	692.15	25.40	33.3	31.8	-
R 79	-	-	-	24	-	-	-	-	692.15	34.93	44.5	41.4	-
R 80	22	-	-	-	-	-	-	-	615.95	7.95	-	12.7	-
R 81	-	22	-	-	-	-	-	-	635.00	14.30	-	19.1	-
R 82*	-	-	-	-	-	-	-	-	57.15	11.13	-	15.9	4.8
R 84*	-	-	-	-	-	-	-	-	63.50	11.13	-	15.9	4.8
R 85*	-	-	-	-	-	-	-	-	79.38	12.70	-	17.5	3.3
R 86*	-	-	-	-	-	-	-	-	90.50	15.88	-	20.6	4.1
R 87*	-	-	-	-	-	-	-	-	100.03	15.88	-	20.6	4.1
R 88*	-	-	-	-	-	-	-	-	123.83	19.05	-	23.9	4.8
R 89*	-	-	-	-	-	-	-	-	114.30	19.05	-	23.9	4.8
R 90*	-	-	-	-	-	-	-	-	155.58	22.23	-	26.9	4.8
R 91*	-	-	-	-	-	-	-	-	260.35	31.75	-	38.1	4.1
R 92	-	-	-	-	-	-	-	-	228.60	11.13	17.5	16.0	-
R 93	-	26	-	-	-	-	-	-	749.30	19.05	-	23.9	-
R 94	-	28	-	-	-	-	-	-	800.10	19.05	-	23.9	-
R 95	-	30	-	-	-	-	-	-	857.25	19.50	-	23.9	-
R 96	-	32	-	-	-	-	-	-	914.40	22.23	-	26.9	-
R 97	-	34	-	-	-	-	-	-	965.20	22.23	-	26.9	-
R 98	-	36	-	-	-	-	-	-	1022.35	-	22.23	-	-
R 99*	-	-	-	-	-	8?	8?	-	234.95	11.13	-	15.9	4.8
R 100	-	-	26	-	-	-	-	-	749.30	28.58	-	35.1	-
R 101	-	-	28	-	-	-	-	-	800.10	31.75	-	38.1	-
R 102	-	-	30	-	-	-	-	-	857.25	31.75	-	38.1	-
R 103	-	-	32	-	-	-	-	-	914.40	31.75	-	38.1	-
R 104	-	-	34	-	-	-	-	-	965.20	34.93	-	38.1	-
R 105	-	-	36	-	-	-	-	-	1022.35	-	34.93	-	-

NOTES

a) R30 Ring Type Joint used for lapped joint only.

Dimensions in mm. Figures stated are for information only. Please refer to the current version of the original standards for dimensional information.

Tolerances: A = width of ring +/-0.20. B, H = height of ring, +1.3, -0.5. Variation in height throughout the entire circumference of any given ring shall not exceed 0.5 within these tolerances
P = average pitch diameter of ring +/-0.18. R1 = radius in ring +/-0.5. 23 deg = angle +/-0 deg 30 min

STYLE RX

The **Style RX** is an adaptation of the standard Style R which is energised when the assembly is pressurised.

The RX is designed to fit the same groove design as a standard Style R, making the joints interchangeable, however consideration should be given to the difference in finished make up distance.

The geometry of this modified design induces a pressure energising effect when the assembly is pressurised, improving the efficiency of the seal.

Designs are also available for subsea applications on existing assets, however, current API 17D does not support use of SRX Ring Type Joints.

STYLE RX TOLERANCES

Dimension	Tolerances (mm)	
	API 6A	ASME B16.20
A Width of ring	+0.20/-0.0	+0.20/-0.00
C Width of flat	+0.15/-0.0	+0.15/-0.00
D Height of outside bevel	+0.0/-0.8	+0.0/-0.76
H Height of ring	+0.20/-0.0	+0.20/-0.00
OD Outside diameter	+0.5/-0.0	+0.51/-0.00
P Average pitch diameter	±0.13	not given
23° Angle of sealing face	±0° 30'	±0° 30'

Surface finish of the Style RX Ring Type Joint sealing faces (23° angled faces) shall not be greater than 1.6 µm Ra / 63 µin RMS.

DIMENSIONAL DATA - STYLE RX

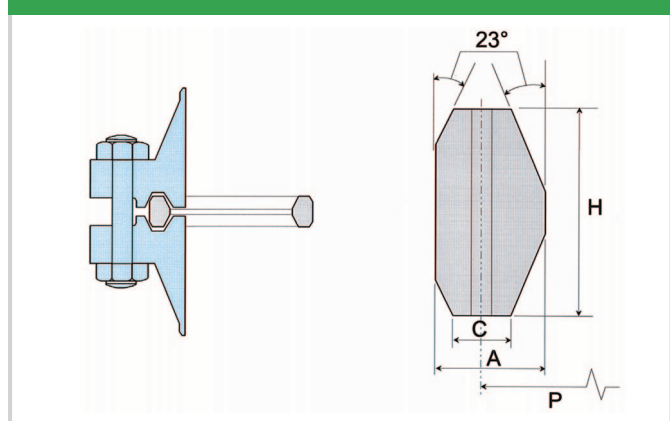

NOTE 1

The pressure passage hole illustrated in the Ring Type Joint cross section ensures equalization of pressure that may be generated in the grooves when the flange assembly is closed. These pressure passage holes are mandatory in the ring sizes RX82-91 inclusive. Centre line of hole shall be located at mid point of dimension "C" (width of flat). Hole diameter shall be as follows:

- 1.5mm 40.5 for rings RX82 through RX85;
- 2.3mm 40.5 (2.4mm 40.5 for API 6A) for rings RX86 and RX87;
- 3.0mm 40.5 for rings RX88 through RX91.

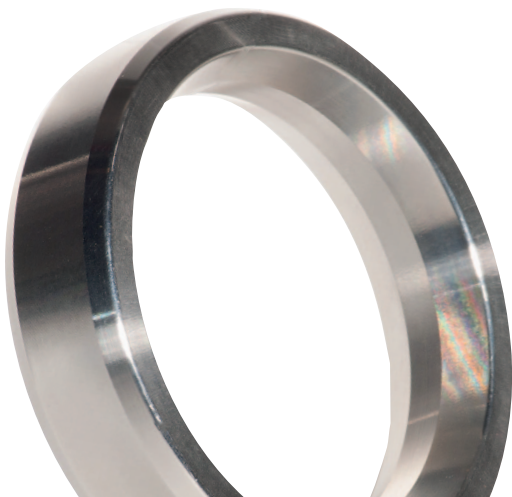

DIMENSIONAL DATA

RING TYPE JOINTS

ASME B16.20 and API 6A

Style RX

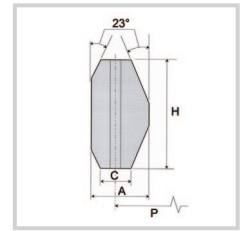

RING NUMBER	PRESSURE CLASS RATINGS - API 6A (psi)			PITCH DIA. OF RING P	OUTSIDE DIAMETER OD	WIDTH OF RING A	WIDTH OF FLAT C	HEIGHT OF OUTSIDE BEVEL D	HEIGHT OF RING H	HOLE SIZE (note 1 & 2) E	APPROX. DIST. BETWEEN MADE UP FLANGES (mm)
	2000	3000	5000								
	NOMINAL PIPE SIZE (inches)										
RX 20	1 1/12	1 1/12	1 1/2	68.26	76.20	8.74	4.62	3.18	19.05	-	9.7
RX 23	2	-	-	82.55	93.27	11.91	6.45	4.24	25.40	-	11.5
RX 24	-	2	2	95.25	105.97	11.91	6.45	4.24	25.40	-	11.5
RX 25	-	-	3 1/8	101.60	109.55	8.74	4.62	3.18	19.05	-	-
RX 26	2 1/2	-	-	101.60	111.91	11.91	6.45	4.24	25.40	-	11.9
RX 27	-	2 1/2	2 1/2	107.95	118.26	11.91	6.45	4.24	25.40	-	11.9
RX 31	3	3	-	123.83	134.54	11.91	6.45	4.24	25.40	-	11.9
RX 35	-	-	3	136.53	147.24	11.91	6.45	4.24	25.40	-	11.9
RX 37	4	4	-	149.23	159.94	11.91	6.45	4.24	25.40	-	11.9
RX 39	-	-	4	161.93	172.64	11.91	6.45	4.24	25.40	-	11.9
RX 41	5	5	-	180.98	191.69	11.91	6.45	4.24	25.40	-	11.9
RX 44	-	-	5	193.68	204.39	11.91	6.45	4.24	25.40	-	11.9
RX 45	6	6	-	211.15	221.84	11.91	6.45	4.24	25.40	-	11.9
RX 46	-	-	6	211.15	222.25	13.49	6.68	4.78	28.58	-	11.9
RX 47	-	-	8	228.60	245.26	19.84	10.34	6.88	41.28	-	18.3
RX 49	8	8	-	269.88	280.59	11.91	6.45	4.24	25.40	-	11.9
RX 50	-	-	8	269.88	283.36	16.66	8.51	5.28	31.75	-	11.9
RX 53	10	10	-	323.85	334.57	11.91	6.45	4.24	25.40	-	11.9
RX 54	-	-	10	323.85	337.34	16.66	8.51	5.28	31.75	-	11.93
RX 57	12	12	-	381.00	391.72	11.91	6.45	4.24	25.40	-	11.9
RX 63	-	-	14	419.10	441.73	27.00	14.78	8.46	50.80	-	21.3
RX 65	16	-	-	469.90	480.62	11.91	6.45	4.24	25.40	-	11.9
RX 66	-	16	-	469.90	483.39	16.66	8.51	5.28	31.75	-	11.9
RX 69	18	-	-	533.40	544.12	11.91	6.45	4.24	25.40	-	11.9
RX 70	-	18	-	533.40	550.06	19.84	10.34	6.88	41.28	-	18.3
RX 73	20	-	-	584.20	596.11	13.49	6.68	5.28	31.75	-	15.0
RX 74	-	20	-	584.20	600.86	19.84	10.34	6.88	41.28	-	18.3
RX 82 (1)	-	-	-	571.5	67.87	11.91	6.45	4.24	25.40	1.5	11.9
RX 84 (1)	-	-	-	63.50	74.22	11.91	6.45	4.24	25.40	1.5	11.9
RX 85 (1)	-	-	-	79.38	90.09	13.49	6.68	4.24	25.40	1.5	9.7
RX 86 (1)	-	-	-	90.50	103.58	15.09	8.51	4.78	28.58	2.3 (2.4)	9.7
RX 87 (1)	-	-	-	100.03	113.11	15.09	8.51	4.78	28.58	2.3 (2.4)	9.7
RX 88 (1)	-	-	-	123.83	139.29	17.48	10.34	5.28	31.75	3.0	9.7
RX 89 (1)	-	-	-	114.30	129.77	18.26	10.34	5.28	31.75	3.0	9.7
RX 90 (1)	-	-	-	155.58	74.63	19.84	12.17	7.42	44.45	3.0	18.3
RX 91 (1)	-	-	-	260.35	286.94	30.18	19.81	7.54	45.24	3.0	19.1
RX 99	-	-	-	234.95	245.67	11.91	6.45	4.24	25.40	-	11.9
RX 201	-	-	13/8	46.05	51.46	5.74	3.20	1.45 (3)	11.30	-	-
RX 205	-	-	1 13/16	57.15	62.31	5.56	3.05	1.83 (3)	11.10	-	-
RX 210	-	-	2 9/16	88.90	97.64	9.53	5.41	3.18 (3)	19.05	-	-
RX 215	-	-	4 1/16	130.18	140.89	11.91	5.33	4.24 (3)	25.40	-	-

GENERAL NOTES

Dimensions in mm. Figures stated are for information only. Please refer to the current version of the original standards for dimensional information.

Tolerances

OD = outside diameter of ring, + 0.51, 0.00. A = width of ring, + 0.20, - 0.00 - Variation in width throughout the entire circumference of any ring shall not exceed 0.10 within these tolerances.

C = width of flat, + 0.15, - 0.00. D = height of outside bevel, + 0.00, - 0.76. H = height of ring, + 0.20, - 0.00 - Variation in height throughout the entire circumference of any ring shall not exceed 0.10 within these tolerances. R1 = radius of ring, +/- 0.5. 23 deg = angle, +/- 0 deg 30 min. E = hole size, +/- 0.5

NOTES

1. Rings RX-82 through RX-91 only require one pressure passage hole as illustrated. The centreline of the hole shall be located at the midpoint of dimension C.

2. Tolerance on these dimensions is + 0.00, - 0.38.

STYLE BX

The **Style BX** energized Ring Type Joints, manufactured in accordance with ASME B16.20, API 6A and API 17D, are designed for use on API 6BX flanges on pressure systems rated up to 20,000 psi.

When correctly fitted, the style BX gasket allows virtual face to face contact of the flange faces which means that the gasket is fully confined on both the inner and outer diameters.

All BX gaskets incorporate a pressure balance hole to ensure equalization of pressure which may be generated in the grooves.

Designs are also available for subsea applications.

STYLE BX TOLERANCES

Dimension	Tolerances (mm)	
	API 6A & 17D	ASME B16.20
A Width of ring	+0.20/-0.0	+0.20/-0.00
C Width of flat	+0.15/-0.0	+0.15/-0.00
D Hole size	+0.5	+0.5
H Height of ring	+0.20/-0.0	+0.20/-0.00
OD Outside diameter	+0.0/-0.15	+0.00/-0.15
ODT Outside diameter of flat	±0.05	±0.05
23° Angle of sealing face	±0° 15'	±0° 15'

Surface finish of the Style BX Ring Type Joint sealing faces (23° angled faces) shall not be greater than 0.8 µm Ra / 32 µin RMS.

DIMENSIONAL DATA - STYLE BX

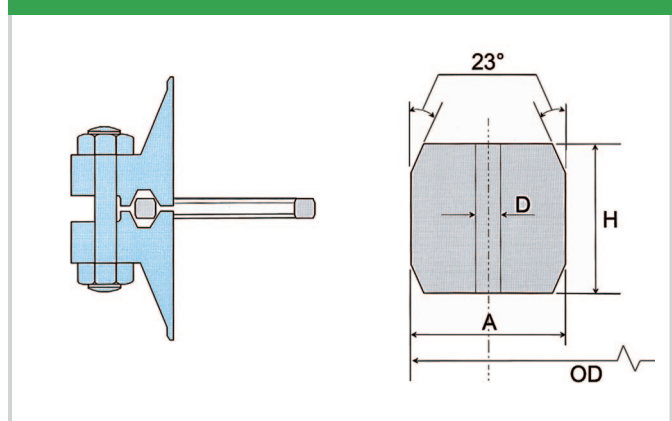

NOTE 1

Machined radii located between all 23° angled sealing facings and the top and bottom flat faces, shall be 8% to 12% of the ring height 'H'.



DIMENSIONAL DATA

RING TYPE JOINTS

ASME B16.20, API 6A and API 17D

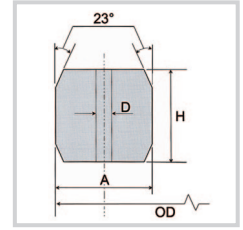

RING NUMBER	NOMINAL SIZE	PRESSURE CLASS RATINGS - API 6BX FLANGES (psi)						OUTSIDE DIAMETER	HEIGHT OF RING	WIDTH OF RING	OUTSIDE DIAMETER OF FLAT	WIDTH OF FLAT	HOLE SIZE (note 1 & 2)
		2000	3000	5000	10000	15000	20000						
		NOMINAL PIPE SIZES (inches)											
BX 150	43	-	-	-	1 11/16	1 11/16	-	72.19	9.30	9.30	70.87	7.98	1.5 (1.6)
BX 151	46	-	-	-	1 13/16	1 13/16	1 13/16	76.40	9.63	9.63	75.03	8.26	1.5 (1.6)
BX 152	52	-	-	-	2 1/16	2 1/16	2 1/16	84.68	10.24	10.24	83.24	8.79	1.5 (1.6)
BX 153	65	-	-	-	2 9/16	2 9/16	2 9/16	100.94	11.38	11.38	99.31	9.78	1.5 (1.6)
BX 154	78	-	-	-	3 1/16	3 1/16	3 1/16	116.84	12.40	12.40	115.09	10.64	1.5 (1.6)
BX 155	103	-	-	-	4 1/16	4 1/16	4 1/16	147.96	14.22	14.22	145.95	12.22	1.5 (1.6)
BX 156	179	-	-	-	7 1/16	7 1/16	7 1/16	237.92	18.62	18.62	235.28	15.98	3.0 (3.2)
BX 157	228 (229)	-	-	-	9	9	9	294.46	20.98	20.98	291.49	18.01	3.0 (3.2)
BX 158	279	-	-	-	11	11	11	352.04	23.14	23.14	348.77	19.86	3.0 (3.2)
BX 159	346	-	-	-	13 5/8	13 5/8	13 5/8	426.72	25.70	25.70	423.09	22.07	3.0 (3.2)
BX 160	346	-	-	13 5/8	-	-	-	402.59	23.83	13.74	399.21	10.36	3.0 (3.2)
BX 161	425 (422)	-	-	16 3/4	-	-	-	491.41	28.07	16.21	487.45	12.24	3.0 (3.2)
BX 162	425 (422)	-	-	16 3/4	16 3/4	16 3/4	-	475.49	14.22	14.22	473.48	12.22	1.5 (1.6)
BX 163	476	-	-	18 3/4	-	-	-	556.16	30.10	17.37	551.89	13.11	3.0 (3.2)
BX 164	476	-	-	-	18 3/4	18 3/4	-	570.56	30.10	24.59	566.29	20.32	3.0 (3.2)
BX 165	540	-	-	21 1/4	-	-	-	624.71	32.03	18.49	620.19	13.97	3.0 (3.2)
BX 166	540	-	-	-	21 1/4	-	-	640.03	32.03	26.14	635.51	21.62	3.0 (3.2)
BX 167	679 (680)	26 3/4	-	-	-	-	-	759.36	35.86 (3)	13.11	754.28	8.03	1.5 (1.6)
BX 168	679 (680)	-	26 3/4	-	-	-	-	765.25	35.86 (3)	16.05	760.17	10.97	1.5 (1.6)
BX 169	130	-	-	-	5 1/8	-	-	173.51	15.85	12.93	171.27	10.69	1.5 (1.6)
BX 170	228 (168)	-	-	-	6 5/8	6 5/8	-	218.03	14.22	14.22	216.03	12.22	1.5 (1.6)
BX 171	279 (218)	-	-	-	8 9/16	8 9/16	-	267.44	14.22	14.22	265.43	12.22	1.5 (1.6)
BX 172	346 (283)	-	-	-	11 5/32	11 5/32	-	333.07	14.22	14.22	331.06	12.22	1.5 (1.6)
BX 303	762	30	30	-	-	-	-	852.75	37.95	16.97	847.37	11.61	1.5 (1.6)

GENERAL NOTES

- Dimensions in mm.
- Figures stated are for information only. Please refer to the current version of the original standards for dimensional information.
- Radius R, shall be 8% to 12% of the gasket height, H.
- Nominal sizes shown in parenthesis are as listed in ASME B16.20.

Tolerances

OD = outside diameter of ring, + 0.00, - 0.15
H = height of ring, + 0.20, - 0.00 - Variation in height throughout the entire circumference of any ring shall not exceed 0.10 within these tolerances.
A = width of ring, + 0.20, - 0.00 - Variation in width throughout the entire circumference of any ring shall not exceed 0.10 within these tolerances.
ODT = outside diameter of flat, +/- 0.05
C = width of flat, + 0.15, - 0.00
D = hole size, +/- 0.5
R = radius of ring [see general note (c)]
23 deg = angle, +/- 0 deg 15 min

NOTE

- One pressure passage hole is required per gasket as illustrated. The centreline of the hole shall be located at the midpoint of dimension C.

OFF-SHORE INDUSTRY RING TYPE JOINTS

STANDARD SUBSEA AND CUSTOM MANUFACTURED SEALS.

SUBSEA GASKETS

Flexitallic is able to provide specialist machined seals that are designed for use in subsea wellhead, mudline and tree equipment within the scope of API 17D.

The Offshore Oil and Gas industry imposes demanding performance requirements on gasketed bolted connections. High pressures and temperatures along with the ever present possibility of corrosion and the need for sub-sea assembly, make the correct gasket style and material selection of crucial importance.

To distinguish subsea Ring Type Joints from those used topside, the suffix "S" is applied to indicate the additional pressure passage hole in the ring cross-section. This additional requirement is to prevent pressure lock occurring when connections are assembled underwater. API 17D provides two drilling options for the pressure passage holes, option A and option B as shown.

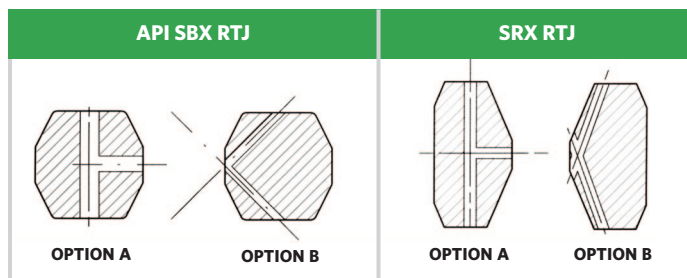

Other than the addition of the pressure passage holes, all other physical aspects of the API 17D SBX Ring Type Joint is the same as the API 6A BX Ring Type Joint.

It should be noted that API 17D no longer supports the use of SRX ring type joints (API 6A RX Ring Type Joints with subsea drillings), however, when opening flanges on existing equipment replacement SRX Ring Type Joints may be used.

CUSTOM MANUFACTURED SEALS

Flexitallic manufactures and supplies specialised machined components to suit various subsea and wellhead equipment such as Blow Out Preventers (BOP). These components are manufactured according to the original equipment manufacturers design and manufacturing procedures.

NORSOK L-005 'IX' SEAL RINGS

IX Seal Rings are designed for use in compact flange connections as detailed in the NORSOK standard. The compact flange design is such that when the flange connection is assembled the tightening / tensioning of the bolts pulls the flange onto the tapered sealing faces on the outside diameter of the IX Seal Ring. The compact flange assembly design has two seals, where the primary seal is the IX Seal Ring and the secondary seal is provided by the application of a seal seating stress at the flange heel.

As with the API ring type joints, the IX Seal Rings are manufactured to very fine tolerances and quality control requirements. Material selection is also very important to avoid corrosion issues. IX Seal Rings are colour coded to denote the metallurgy used.

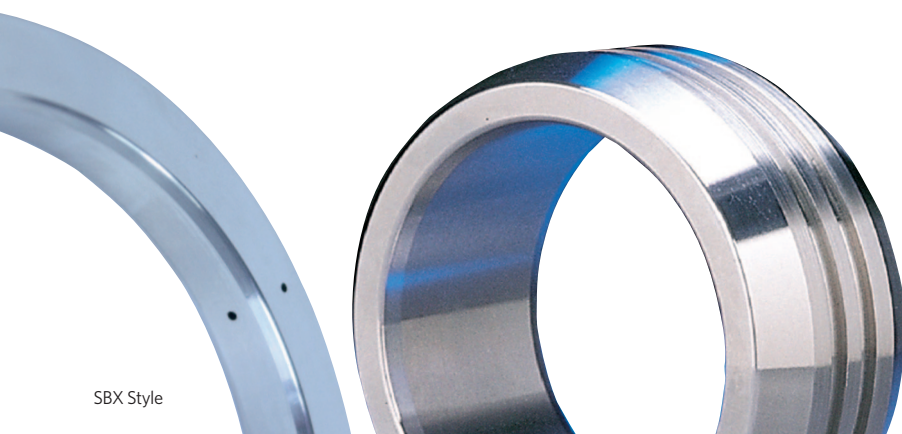

Special BOP Type Joint

SPECIALISED RING TYPE JOINTS

RUBBER COATED RING TYPE JOINTS. BLIND AND ORIFICE RING TYPE JOINTS.

RUBBER COATED RING TYPE JOINTS

This is an oval Ring Type Joint totally enclosed in a nitrile rubber coating. The Ring Type Joint material is usually soft iron or low carbon steel.

This type of gasket has three main functions:

- It is used in pressure testing to minimise damage to flanges.
- The rubber contact points provide additional seals while protecting the flange surfaces.
- It provides increased assurance against corrosion, which can occur between conventional Ring Type Joints and the engaged surfaces of the groove.

A wide range of standard sizes are available, with special sizes available upon request.

STYLE R AND RX WITH PTFE INSERTS

Style R and RX Ring Type Joints can also be supplied with PTFE inserts, in order to reduce turbulent flow and eliminate gasket/flange erosion.

For the RX style Ring Type Joints, the insert is specially designed with radially drilled pressure passage holes so that the self energising performance of the RX Ring Joint is not impaired.

As can be seen in the sectional view, the insert is located between the inside diameter of the Ring Type Joint and the bore of the flange.

On assembly, the insert is completely trapped between the make up of the flanges, filling the annular space between the flange bore and gasket.

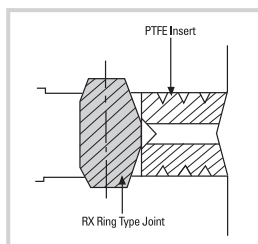

SECTION THROUGH RX RING
WITH INSERT

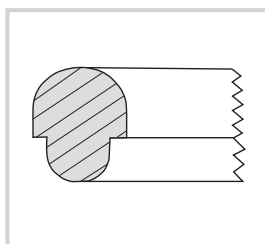

TRANSITION RING

TRANSITION RING TYPE JOINTS

These are combination rings which consist of two different sizes having the same pitch circle diameter. They are used for sealing Ring Type Joint flanges where the mating flanges have different ring groove geometry.

Transition Ring Type Joints can be manufactured from standard materials, as well as exotic alloys. Transition Ring Type Joints are available with either oval or octagonal facings and are not encompassed within the API or ASME specifications.

BLIND AND ORIFICE RING TYPE JOINTS

Blind Ring Type Joints can be manufactured to blank off flanges and pipework. They consist of standard Ring Type Joints with integral solid metal centres. The height of the standard Ring Type Joint section of the gasket is increased to allow for the solid centre to fit in between the two flanges and permit the sealing faces to locate correctly inside the ring grooves.

Orifice Ring Type Joints are used for either restricting and / or measuring fluid flow and are sized to customer requirements. As with the Blind Ring Type Joints the height of the Ring Type Joint section is increased to allow for the thickness of the orifice plate.

Blind Ring Type Joints can be supplied in all standard and exotic materials.

Unless instructed otherwise, Blind / Blank thicknesses are calculated in accordance with ASME B31.3.

For further information on specialised Ring Type Joint products, please contact Flexitallic's Applications Engineering Department.



RTJ with PTFE Insert

SPECIALISED RING TYPE JOINTS

FOR CRITICAL AND NON- STANDARD APPLICATIONS, FLEXITALLIC OFFERS A RANGE OF SPECIALISED RING TYPE JOINTS TO SUIT THE NEEDS OF THE OIL & GAS AND PETROCHEMICAL INDUSTRIES.

FRG-RJ

The Flexitallic FRG-RJ is comprised of a standard geometry ring joint ensuring the primary seal is effected as originally designed, there is also a integrated secondary seal comprised of a high integrity serrated metal Flexpro core faced with Flexitallic's highly conformable re-structured microcellular PTFE. This secondary seal is carefully dimensioned to fill any voids or crevices formed between the pipe-bore and the internal diameter of standard Ring Type Joint on flange closure. The highly conformable nature and optimized thickness of the inner secondary seal ensures that it is capable of adapting to extensively damaged flange sealing surfaces. Full closure of this corrosion / erosion sensitive area prevents fluid ingress mitigating the potential for further flange damage. This gasket design can also be used as part of a preventative maintenance programme.

LENS RINGS

The Lens Ring is a metallic gasket design incorporating spherical seating faces designed to suit a specific mating flange profile, providing the user with a high integrity, high pressure/ temperature metal to metal seal. Lens Ring gasket technology is covered solely by the DIN 2696 specification, however, other flange standards can be modified to accept the Lens Ring.

As with all metallic gaskets, the Lens Ring material should be specified softer than the flange material, thus ensuring applied compressive load leads to the elastic/plastic deformation of the lens ring and not the flange sealing face. The distribution of high compressive loads leads to the spread of the gasket facings, ensuring over stressing of the gasket is prevented.

In accordance with DIN 2696 general materials are limited to a range of specified carbon and stainless steel grades, although alternative grades are available upon request. Flexitallic requires a detailed drawing to be supplied when ordering non-standard Lens Rings.

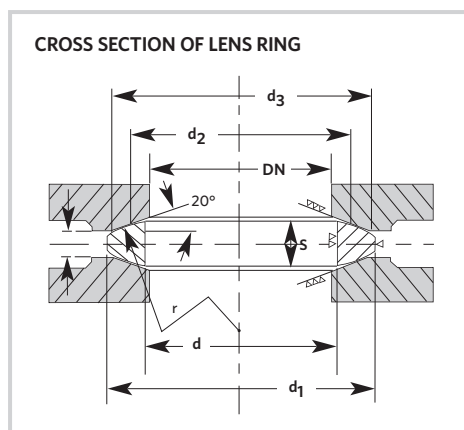
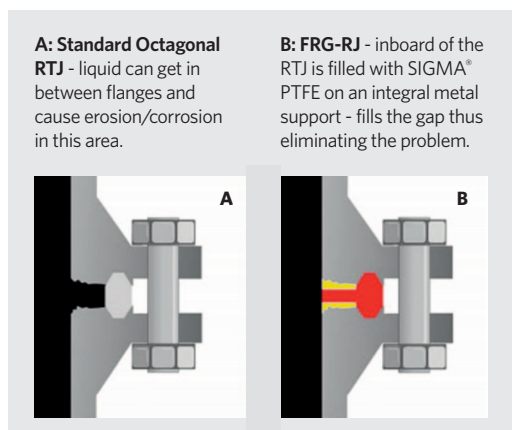

FRG-RJ



Lens Ring

FLEXPRO™ FACED RTJ'S

**FOR USE IN DAMAGED FLANGES OR
AS RE-USABLE RING TYPE JOINTS.**

KAMM-ORJ. KAMM-RX.

FLEXPRO™ FACED RING TYPE JOINT

The Flexitallic style Flexpro™ faced Ring Type Joints are suitable for use in high pressure applications where API or ASME ring groove style flanges are to be sealed.

The Ring Type Joint metallurgy is generally specified by the customer to match the flange material and to be suitable for the application media. The relevant 23° angled sealing faces of the Ring Type Joint are machined with concentric serrations to provide a low stress sealing face to which a soft sealing material is applied. This low stress sealing capability avoids the need to deform the metal of the Ring Type Joint. Standard Ring Type Joints can only be used once, however, after careful removal of the used soft facing material and inspection confirming the integrity and quality of the metal Ring Type Joint, the facing material is replaced and the Flexpro™ faced Ring Type Joint re-used.

SOFT SEALING MATERIALS

The soft materials that are applied to the sealing faces of the Flexpro™ faced Ring Type Joints are Flexicarb® or Thermiculite®. Maximum operating temperatures are dependent upon the metallurgy and the facing material selected:

Flexicarb®	450°C (842°F)
Thermiculite®	980°C (1800°F)

COMPLIANCE

The underlying metallic Ring Type Joint conforms to the dimensional requirements of the relevant API or ASME standard. NACE compliant material can be supplied upon request.

KAMM-ORJ

The Flexitallic Kamm-ORJ is a solid metallic style 'R' Octagonal Ring Type Joint with the soft sealing material applied to all four pre-serrated 23° angled sealing faces as shown.

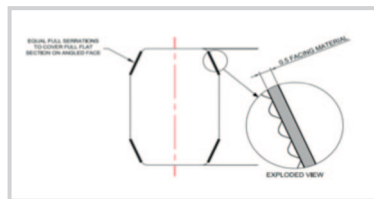

KAMM-RX

The Flexitallic Kamm-RX gasket (also known as KAMM-PEG) is a solid metallic style 'RX' Pressure Energised Ring Type Joint, where the top and bottom 23° angled sealing faces on the outer diameter are serrated and faced with a soft sealing material.

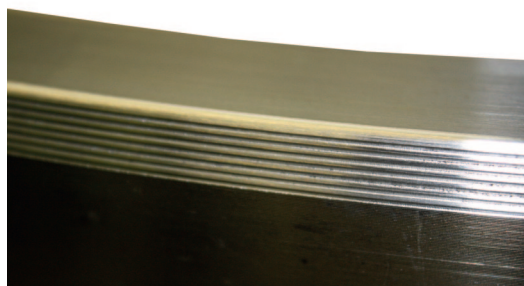
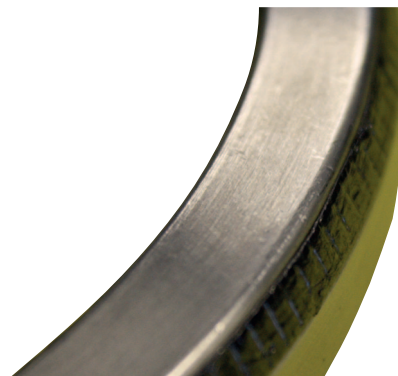
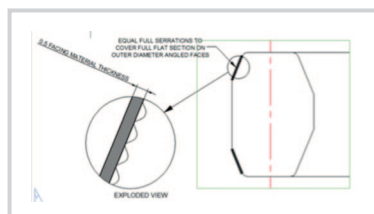

UNITED KINGDOM

Flexitallic UK Ltd.

Scandinavia Mills
Hunsworth Lane
Cleckheaton
West Yorkshire, BD19 4LN
UK
Tel: +44 1274 851273
customerservice@flexitallic.eu

*Branches also in Aberdeen,
Middlesbrough, Ellesmere Port
and South West.*

ITALY

Flexitallic Italy Sr.l

Via Leonardo Da Vinci 6B
26020 Ticengo CR
ITALY
Tel: +39 0374 71006
info@flexitallic.it

INDIA

Flexitallic India Pvt. Ltd.

Building GB320, Unit B
Talegaon Industrial Parks Pvt. Ltd.
Gut No:12, Maval Taluka
Badhalawadi
Pune - 410507
Maharashtra
INDIA
Tel: +91 9850577447
customerservice@flexitallic.in

FRANCE

Siem Supranite

a Flexitallic Company

31-33 Rue de Mogador
75009 Paris
FRANCE
Tel: +33 (0)1 48 88 88 88
contact@supranite.com
www.siem.fr

UNITED ARAB EMIRATES

Flexitallic LLC

PO Box No. 6591-AI Jazeera
Plot 108, Road E
Al Hamra Industrial Area
Ras Al Khaimah
UNITED ARAB EMIRATES
Tel: +971 7 202 5300
sales-me@flexitallic.com

*Branches also in Abu Dhabi,
Oman and Qatar.*

AUSTRALIA

Flexitallic Australia Pty Ltd.

13-15 Vinnicombe Drive
Canning Vale
Perth, WA 6155
AUSTRALIA
Tel: +61 (0)8 9455 2155
customerservice@flexitallic.au

*Branch also in Melbourne,
Victoria.*

GERMANY

Flexitallic GmbH

Halskestr. 13
47877 Willich
GERMANY
Tel: +49 (0) 2154 95363-0
customerservice@flexitallic.de

CHINA

Flexitallic Gasket Technology (Suzhou) Co., Ltd

Building A, 1868 Guangming Rd
Technological Development Zone
Wujiang Economic 215200
CHINA
Tel: +86 512 6303 2839
FGT-customerservice@flexitallic.com

UNITED STATES

Flexitallic US LLC

6915 Highway 225
Deer Park
Texas 77536
USA
Tel: +1 281 604 2400
dpquotes@flexitallic.com

MEXICO

Flexitallic Mexico/Equiter SA de CV

Calle 28 #2571
Zona Industrial Bienestar Social
Guadalajara, Jalisco
MEXICO. CP 44940
Tel: +52 33 3145 3454/1763
mexico@flexitallic.com

BENELUX

Flexitallic Benelux BVBA

Smallandlaan 21
2660 Hoboken
BELGIUM
Tel: + 32 3 369 19 68
benelux@flexitallic.eu

THAILAND

Flexitallic Sealing Technology Co Ltd.

No. 7/456, Moo 6,
Amata City Rayong Industrial Estate
Mabyangporn Sub-district
Pluak Daeng District
Rayong Province
THAILAND
Tel: +66 (0)33017561 - 3
FST-customerservice@flexitallic.com

CANADA

Flexitallic Canada Ltd.

4340 - 78 Avenue
Edmonton
Alberta, T6B 3J5
CANADA
Tel: +780 466 5050
Sales@flexitallic.ca

About The Flexitallic Group

The Flexitallic Group is a global leader in specialised sealing solutions and products serving the oil and gas, power generation, chemical and petrochemical industries in emerging and developed markets. Focused on the upstream, downstream and power generation sectors, it has operations in France, the United States, Canada, Mexico, the United Kingdom, Germany, Italy, Belgium, the Middle East, India, Thailand, Australia and China plus a network of worldwide licensing partners and distributors.